

| DEALER | | | COLOURS INFORMATION For Office Use Only | | |
|----------------|--|--------|---|----------------|-----------|
| Dealer: | | | Order Date: | | S/N: |
| Account: | | P.O.#: | RTS | | |
| Ordered By: | | | RTS: | | Phone: |
| Address: | | | Email: | | |
| City: | | State: | Zip: | | |
| Phone: | | Fax: | | SHIP TO | |
| Email: | | | Name: | | Ship Via: |
| Customer Name: | | | Address: | | |
| Note | | | City: | | State: |
| | | | Phone: | | Fax: |

| CHAIR INFORMATION | PRICE |
|-----------------------------|--|
| SPAZZ K0005 | Base Wheel Chair Price K0005 \$ 2,400 |
| Adjustable FSH-RSH | Total Section A \$ |
| Max. Capacity 250Lbs | Total Section B \$ |
| NOTE | Total Section C \$ |
| | Total Section D \$ |
| | Total Section E \$ |
| | Total Section F (Custom Parts Color) \$ |
| | ORDER GRAND TOTAL \$ |

A FRAME COLORS & PARTS COLORS

| FRAME COLORS | | |
|---|---|----------------------------|
| Powder-Coated | <input type="checkbox"/> Gloss Black <input type="checkbox"/> Twilight Flake <input type="checkbox"/> Yellow <input type="checkbox"/> Magenta <input type="checkbox"/> Fire Engine Red <input type="checkbox"/> White <input type="checkbox"/> Candy Blue <input type="checkbox"/> Candy Purple <input type="checkbox"/> Candy Green <input type="checkbox"/> Candy Red <input type="checkbox"/> Candy Raspberry <input type="checkbox"/> Cobalt Blue <input type="checkbox"/> Matte Gray <input type="checkbox"/> Matte Purple <input type="checkbox"/> Matte Blue <input type="checkbox"/> Matte Green <input type="checkbox"/> Matte Black <input type="checkbox"/> Matte Red <input type="checkbox"/> Neon Red <input type="checkbox"/> Neon Green <input type="checkbox"/> Orange Sparkle <input type="checkbox"/> Mellon Yellow <input type="checkbox"/> Gun Smoke Silver <input type="checkbox"/> Pigeon Blue <input type="checkbox"/> Copper <input type="checkbox"/> Granny Sparkle Green <input type="checkbox"/> Sparkle Sky Blue <input type="checkbox"/> Vermilion <input type="checkbox"/> Reed Green <input type="checkbox"/> Blue Lilac | \$ STD |
| Special Colors | <input type="checkbox"/> Polished Aluminum..... <input type="checkbox"/> 24 karat Gold Plated..... | \$ 800 \$ CFP |
| PARTS COLORS (Custom Parts Color Section, Please see Section F) | | |
| STD Color | Black Color (*Suspension Springs-Silver Color Only)..... | \$ STD |
| Custom Color Main Bolt on Parts One Color Package | <input type="checkbox"/> Powder-Coated () <input type="checkbox"/> Polished Aluminum..... <input type="checkbox"/> 24 karat Gold Plated..... | \$ 500 \$ 750 \$ CFP |
| Including: Backrest, Foot Plate, Footrest Rings, Backrest Brackets, Saddle Stops, Forks & Knurl Nuts, Caps, Front Suspension Springs, Axle Tube, Axle Plates, Axle Bases, Camber Discs★marked parts | | |
| | | |
| Total Section A | | \$ |

B FRAME MEASUREMENTS 1/2

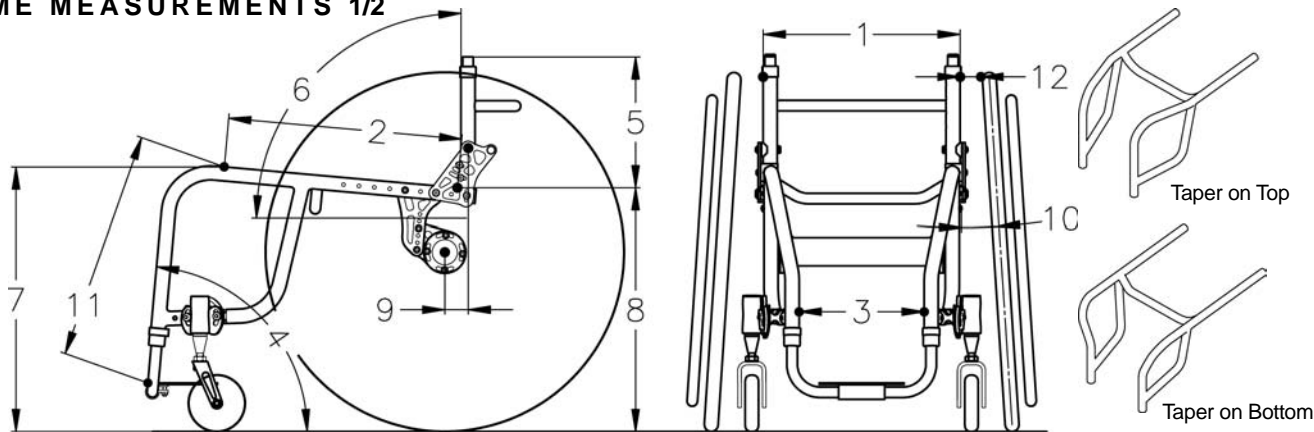

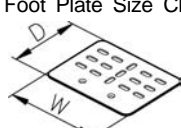
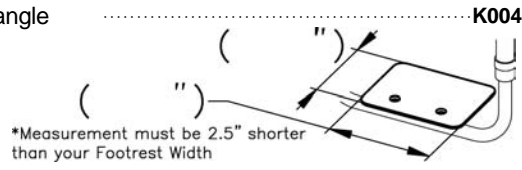
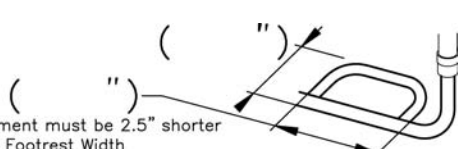
| FRAME | <input type="checkbox"/> STD Frame (Max. Capacity 250Lbs) | \$ STD | | | | | | | | |
|----------------------------------|---|---|---------------------|-----------------|------------|-----------------|-------------|---------------------|-------------|----------------------|
| | <input type="checkbox"/> Heavy Duty Frame (Max. Capacity 300Lbs) | \$ 750 | | | | | | | | |
| | <input type="checkbox"/> Super Heavy Duty Frame (Max. Capacity 350Lbs) | \$ 1500 | | | | | | | | |
| 1. SEAT WIDTH | <input type="checkbox"/> 14" <input type="checkbox"/> 15" <input type="checkbox"/> 16" <input type="checkbox"/> 17" <input type="checkbox"/> 18" | \$ STD | | | | | | | | |
| | <input type="checkbox"/> 19" <input type="checkbox"/> 20" | \$ 284 | | | | | | | | |
| 2. SEAT DEPTH | <input type="checkbox"/> Net Seat Depth <input type="checkbox"/> 13" <input type="checkbox"/> 14" <input type="checkbox"/> 15" <input type="checkbox"/> 16" <input type="checkbox"/> 17" <input type="checkbox"/> 18" <input type="checkbox"/> 19" | \$ STD | | | | | | | | |
| | <input type="checkbox"/> 20" | E2203 \$ 250 | | | | | | | | |
| | Depth Adj. Frame <input type="checkbox"/> Short Frame (16" Depth) Set at <input type="checkbox"/> 13" <input type="checkbox"/> 14" <input type="checkbox"/> 15" <input type="checkbox"/> 16" | \$ STD | | | | | | | | |
| | <input type="checkbox"/> Long Frame (19" Depth) Set at <input type="checkbox"/> 16" <input type="checkbox"/> 17" <input type="checkbox"/> 18" <input type="checkbox"/> 19" | \$ STD | | | | | | | | |
| | <input type="checkbox"/> Positioning Frame Add (") | \$ 150 | | | | | | | | |
| 3. FOOTREST WIDTH | <input type="checkbox"/> STD (Seat Width Minus 5", Taper on Bottom Frame) | \$ STD | | | | | | | | |
| | <input type="checkbox"/> Custom (") <input type="checkbox"/> Taper on Top <input type="checkbox"/> Taper on Bottom | \$ 150 | | | | | | | | |
| | <input type="checkbox"/> No Taper (Seat Width Minus 2") | \$ NCO | | | | | | | | |
| FOOT PLATE STYLE | <input type="checkbox"/> Standard single loop with adjust. height & angle. STD Foot Plate | K0040 \$ STD | | | | | | | | |
| | <input type="checkbox"/> Single Flip-Back-single loop (no riser avail) with adjust. height & angle. STD Foot Plate | K0040 \$ 150 | | | | | | | | |
| STD Foot Plate Size Chart |  | <table border="1"> <thead> <tr> <th>Your Footrest Width</th> <th>Foot Plate Size</th> </tr> </thead> <tbody> <tr> <td>8.5"-10.5"</td> <td>STD (W6.5"xD5")</td> </tr> <tr> <td>11.0"-13.0"</td> <td>Large (W8.5"xD6.5")</td> </tr> <tr> <td>13.5"-17.0"</td> <td>X-Large (W11"xD6.5")</td> </tr> </tbody> </table> | Your Footrest Width | Foot Plate Size | 8.5"-10.5" | STD (W6.5"xD5") | 11.0"-13.0" | Large (W8.5"xD6.5") | 13.5"-17.0" | X-Large (W11"xD6.5") |
| | Your Footrest Width | Foot Plate Size | | | | | | | | |
| 8.5"-10.5" | STD (W6.5"xD5") | | | | | | | | | |
| 11.0"-13.0" | Large (W8.5"xD6.5") | | | | | | | | | |
| 13.5"-17.0" | X-Large (W11"xD6.5") | | | | | | | | | |
| CUSTOM FOOT PLATE | <input type="checkbox"/> Custom Foot Plate. with adjust. height & angle | K0040 \$ 75 | | | | | | | | |
| |  | | | | | | | | | |
| | <input type="checkbox"/> Custom Tubular Footrest | \$ 250 | | | | | | | | |
| |  | | | | | | | | | |
| | <input type="checkbox"/> With ABS Foot Plate (\$65 up charge) | | | | | | | | | |
| 4. FRAME ANGLE | <input type="checkbox"/> 75° <input type="checkbox"/> 80° <input type="checkbox"/> 85° <input type="checkbox"/> 90° to the ground | \$ STD | | | | | | | | |
| | <input type="checkbox"/> Custom (°) to the ground | \$ NCO | | | | | | | | |

B FRAME MEASUREMENTS 2/2

| | | | | | | | | | | | | | | | | | | | | | | | | | | | | | | | | | | | | | | | | | | | | | | | | | | | | | | | | | | | | | | | | | | | | | | | | | | | | | | | | | | | | | | | | | | | | | | | | | | | | | | | | | | | | | | | | | |
|--|---|--|--------------------------|--|--------------------------|--------------------------|--------------------------|--------------------------|--------------------------|--------------------------|--------------------------|--|-------|-----------------|--------------|-------|-------|-------------|--------------|----------------------|-----------------------|--------------------------|--------------------------|--------------------------|--------------------------|--------------------------|--------------------------|--------------------------|--------------------------|--------------------------|--------------------------|--------------------------|--------------------------|--------------------------|--------------------------|--------------------------|-----------------------|--------------------------|--------------------------|--------------------------|--------------------------|--------------------------|--------------------------|--------------------------|--------------------------|--------------------------|--------------------------|--------------------------|--------------------------|--------------------------|--------------------------|--------------------------|--------------------------|--------------------------|--------------------------|--------------------------|--------------------------|--------------------------|--------------------------|--------------------------|--------------------------|--------------------------|--------------------------|--------------------------|--------------------------|--------------------------|--------------------------|--------------------------|--------------------------|--------------------------|--------------------------|--------------------------|--------------------------|--------------------------|--------------------------|--------------------------|--------------------------|--------------------------|--------------------------|--------------------------|--------------------------|--------------------------|--------------------------|--------------------------|--------------------------|--------------------------|--------------------------|--------------------------|--------------------------|--------------------------|--------------------------|--------------------------|--------------------------|--------------------------|--------------------------|--------------------------|--------------------------|--------------------------|--------------------------|--------------------------|--------------------------|--------------------------|-----|--------------------------|--------------------------|--------------------------|--------------------------|--------------------------|--------------------------|--------------------------|--------------------------|--------------------------|--------------------------|
| 5. BACKREST HEIGHT <small>* Rigidizer bar 3.25" deep std.</small> | <input type="checkbox"/> 8" <input type="checkbox"/> 9" <input type="checkbox"/> 10" <input type="checkbox"/> 11" <input type="checkbox"/> 12" <input type="checkbox"/> 13" <input type="checkbox"/> 14" <input type="checkbox"/> 15" <input type="checkbox"/> 16" <input type="checkbox"/> 17" <input type="checkbox"/> 18" | Adj. Range Adj. Range Adj. Range | \$ STD | | | | | | | | | | | | | | | | | | | | | | | | | | | | | | | | | | | | | | | | | | | | | | | | | | | | | | | | | | | | | | | | | | | | | | | | | | | | | | | | | | | | | | | | | | | | | | | | | | | | | | | | | | | | | | |
| Type | <input type="checkbox"/> Folding with adjust. height & angle | | \$ STD | | | | | | | | | | | | | | | | | | | | | | | | | | | | | | | | | | | | | | | | | | | | | | | | | | | | | | | | | | | | | | | | | | | | | | | | | | | | | | | | | | | | | | | | | | | | | | | | | | | | | | | | | | | | | | |
| | <input type="checkbox"/> Locking mechan. with adjust. height & angle | | \$ STD | | | | | | | | | | | | | | | | | | | | | | | | | | | | | | | | | | | | | | | | | | | | | | | | | | | | | | | | | | | | | | | | | | | | | | | | | | | | | | | | | | | | | | | | | | | | | | | | | | | | | | | | | | | | | | |
| | <input type="checkbox"/> Double Locking mechan. with adjust. height & angle | | \$ 25 | | | | | | | | | | | | | | | | | | | | | | | | | | | | | | | | | | | | | | | | | | | | | | | | | | | | | | | | | | | | | | | | | | | | | | | | | | | | | | | | | | | | | | | | | | | | | | | | | | | | | | | | | | | | | | |
| | <input type="checkbox"/> Welded Backrest Angle Set at () to the ground *Non Folding only | | \$ 150 | | | | | | | | | | | | | | | | | | | | | | | | | | | | | | | | | | | | | | | | | | | | | | | | | | | | | | | | | | | | | | | | | | | | | | | | | | | | | | | | | | | | | | | | | | | | | | | | | | | | | | | | | | | | | | |
| | <input type="checkbox"/> Welded Side Guards | | \$ 450 | | | | | | | | | | | | | | | | | | | | | | | | | | | | | | | | | | | | | | | | | | | | | | | | | | | | | | | | | | | | | | | | | | | | | | | | | | | | | | | | | | | | | | | | | | | | | | | | | | | | | | | | | | | | | | |
| CUSTOM | <input type="checkbox"/> Non Folding Backrest Only | | | | | | | | | | | | | | | | | | | | | | | | | | | | | | | | | | | | | | | | | | | | | | | | | | | | | | | | | | | | | | | | | | | | | | | | | | | | | | | | | | | | | | | | | | | | | | | | | | | | | | | | | | | | | | | | |
| | <input type="checkbox"/> Custom Backrest (ie: double rigidizer bars, custom depth, etc) | | \$ 150 | | | | | | | | | | | | | | | | | | | | | | | | | | | | | | | | | | | | | | | | | | | | | | | | | | | | | | | | | | | | | | | | | | | | | | | | | | | | | | | | | | | | | | | | | | | | | | | | | | | | | | | | | | | | | | |
| | | | | | | | | | | | | | | | | | | | | | | | | | | | | | | | | | | | | | | | | | | | | | | | | | | | | | | | | | | | | | | | | | | | | | | | | | | | | | | | | | | | | | | | | | | | | | | | | | | | | | | | | | | | | | | | | | |
| 6. BACKREST ANGLE | Set at (°) to the ground *STD 90° | | \$ STD | | | | | | | | | | | | | | | | | | | | | | | | | | | | | | | | | | | | | | | | | | | | | | | | | | | | | | | | | | | | | | | | | | | | | | | | | | | | | | | | | | | | | | | | | | | | | | | | | | | | | | | | | | | | | | |
| 7. FRONT SEAT HEIGHT | <input type="checkbox"/> 17.5" <input type="checkbox"/> 18.0" <input type="checkbox"/> 18.5" <input type="checkbox"/> 19.0" <input type="checkbox"/> 19.5" <input type="checkbox"/> 20.0" <input type="checkbox"/> 20.5" | | \$ STD | | | | | | | | | | | | | | | | | | | | | | | | | | | | | | | | | | | | | | | | | | | | | | | | | | | | | | | | | | | | | | | | | | | | | | | | | | | | | | | | | | | | | | | | | | | | | | | | | | | | | | | | | | | | | | |
| The front seat heights are impacted by the size of your front caster. | | | | | | | | | | | | | | | | | | | | | | | | | | | | | | | | | | | | | | | | | | | | | | | | | | | | | | | | | | | | | | | | | | | | | | | | | | | | | | | | | | | | | | | | | | | | | | | | | | | | | | | | | | | | | | | | | |
| <table border="1" style="width:100%; border-collapse: collapse;"> <tr> <td colspan="2" rowspan="2" style="text-align:center;"> Front Seat Height Ranges * =Not Available with Quick Release Caster Axle. </td> <td colspan="7" style="text-align:center;">Front Seat Height</td> </tr> <tr> <td style="width:10%;">17.5"</td> <td style="width:10%;">18.0"</td> <td style="width:10%;">18.5"</td> <td style="width:10%;">19.0"</td> <td style="width:10%;">19.5"</td> <td style="width:10%;">20.0"</td> <td style="width:10%;">20.5"</td> </tr> <tr> <td rowspan="8" style="writing-mode: vertical-rl; transform: rotate(180deg);">Your Casters & Forks</td> <td>3" Caster & STD Forks</td> <td><input type="checkbox"/></td> <td><input type="checkbox"/></td> <td><input type="checkbox"/></td> <td><input type="checkbox"/></td> <td><input type="checkbox"/></td> <td><input type="checkbox"/></td> <td><input type="checkbox"/></td> </tr> <tr> <td>3" Caster & Springs</td> <td><input type="checkbox"/></td> <td><input type="checkbox"/></td> <td><input type="checkbox"/></td> <td><input type="checkbox"/></td> <td><input type="checkbox"/></td> <td><input type="checkbox"/></td> <td><input type="checkbox"/></td> </tr> <tr> <td>3" Caster & Frog Legs</td> <td><input type="checkbox"/></td> <td><input type="checkbox"/></td> <td><input type="checkbox"/></td> <td><input type="checkbox"/></td> <td><input type="checkbox"/></td> <td><input type="checkbox"/></td> <td><input type="checkbox"/></td> </tr> <tr> <td>4" Caster & STD Forks</td> <td><input type="checkbox"/></td> <td><input type="checkbox"/></td> <td><input type="checkbox"/></td> <td><input type="checkbox"/></td> <td><input type="checkbox"/></td> <td><input type="checkbox"/></td> <td><input type="checkbox"/></td> </tr> <tr> <td>4" Caster & Springs</td> <td><input type="checkbox"/></td> <td><input type="checkbox"/></td> <td><input type="checkbox"/></td> <td><input type="checkbox"/></td> <td><input type="checkbox"/></td> <td><input type="checkbox"/></td> <td><input type="checkbox"/></td> </tr> <tr> <td>4" Caster & Frog Legs</td> <td><input type="checkbox"/></td> <td><input type="checkbox"/></td> <td><input type="checkbox"/></td> <td><input type="checkbox"/></td> <td><input type="checkbox"/></td> <td><input type="checkbox"/></td> <td><input type="checkbox"/></td> </tr> <tr> <td>5" Caster & STD Forks</td> <td><input type="checkbox"/></td> <td><input type="checkbox"/></td> <td><input type="checkbox"/></td> <td><input type="checkbox"/></td> <td><input type="checkbox"/></td> <td><input type="checkbox"/></td> <td><input type="checkbox"/></td> </tr> <tr> <td>5" Caster & Springs</td> <td><input type="checkbox"/></td> <td><input type="checkbox"/></td> <td><input type="checkbox"/></td> <td><input type="checkbox"/></td> <td><input type="checkbox"/></td> <td><input type="checkbox"/></td> <td><input type="checkbox"/></td> </tr> <tr> <td>5" Caster & Frog Legs</td> <td><input type="checkbox"/></td> <td><input type="checkbox"/></td> <td><input type="checkbox"/></td> <td><input type="checkbox"/></td> <td><input type="checkbox"/></td> <td><input type="checkbox"/></td> <td><input type="checkbox"/></td> </tr> </table> | | | | Front Seat Height Ranges * =Not Available with Quick Release Caster Axle. | | Front Seat Height | | | | | | | 17.5" | 18.0" | 18.5" | 19.0" | 19.5" | 20.0" | 20.5" | Your Casters & Forks | 3" Caster & STD Forks | <input type="checkbox"/> | <input type="checkbox"/> | <input type="checkbox"/> | <input type="checkbox"/> | <input type="checkbox"/> | <input type="checkbox"/> | <input type="checkbox"/> | 3" Caster & Springs | <input type="checkbox"/> | <input type="checkbox"/> | <input type="checkbox"/> | <input type="checkbox"/> | <input type="checkbox"/> | <input type="checkbox"/> | <input type="checkbox"/> | 3" Caster & Frog Legs | <input type="checkbox"/> | <input type="checkbox"/> | <input type="checkbox"/> | <input type="checkbox"/> | <input type="checkbox"/> | <input type="checkbox"/> | <input type="checkbox"/> | 4" Caster & STD Forks | <input type="checkbox"/> | <input type="checkbox"/> | <input type="checkbox"/> | <input type="checkbox"/> | <input type="checkbox"/> | <input type="checkbox"/> | <input type="checkbox"/> | 4" Caster & Springs | <input type="checkbox"/> | <input type="checkbox"/> | <input type="checkbox"/> | <input type="checkbox"/> | <input type="checkbox"/> | <input type="checkbox"/> | <input type="checkbox"/> | 4" Caster & Frog Legs | <input type="checkbox"/> | <input type="checkbox"/> | <input type="checkbox"/> | <input type="checkbox"/> | <input type="checkbox"/> | <input type="checkbox"/> | <input type="checkbox"/> | 5" Caster & STD Forks | <input type="checkbox"/> | <input type="checkbox"/> | <input type="checkbox"/> | <input type="checkbox"/> | <input type="checkbox"/> | <input type="checkbox"/> | <input type="checkbox"/> | 5" Caster & Springs | <input type="checkbox"/> | <input type="checkbox"/> | <input type="checkbox"/> | <input type="checkbox"/> | <input type="checkbox"/> | <input type="checkbox"/> | <input type="checkbox"/> | 5" Caster & Frog Legs | <input type="checkbox"/> | <input type="checkbox"/> | <input type="checkbox"/> | <input type="checkbox"/> | <input type="checkbox"/> | <input type="checkbox"/> | <input type="checkbox"/> | | | | | | | | | | | | | | | | | | | | | |
| Front Seat Height Ranges * =Not Available with Quick Release Caster Axle. | | Front Seat Height | | | | | | | | | | | | | | | | | | | | | | | | | | | | | | | | | | | | | | | | | | | | | | | | | | | | | | | | | | | | | | | | | | | | | | | | | | | | | | | | | | | | | | | | | | | | | | | | | | | | | | | | | | | | | | | |
| | | 17.5" | 18.0" | 18.5" | 19.0" | 19.5" | 20.0" | 20.5" | | | | | | | | | | | | | | | | | | | | | | | | | | | | | | | | | | | | | | | | | | | | | | | | | | | | | | | | | | | | | | | | | | | | | | | | | | | | | | | | | | | | | | | | | | | | | | | | | | | | | | | | | |
| Your Casters & Forks | 3" Caster & STD Forks | <input type="checkbox"/> | <input type="checkbox"/> | <input type="checkbox"/> | <input type="checkbox"/> | <input type="checkbox"/> | <input type="checkbox"/> | <input type="checkbox"/> | | | | | | | | | | | | | | | | | | | | | | | | | | | | | | | | | | | | | | | | | | | | | | | | | | | | | | | | | | | | | | | | | | | | | | | | | | | | | | | | | | | | | | | | | | | | | | | | | | | | | | | | | |
| | 3" Caster & Springs | <input type="checkbox"/> | <input type="checkbox"/> | <input type="checkbox"/> | <input type="checkbox"/> | <input type="checkbox"/> | <input type="checkbox"/> | <input type="checkbox"/> | | | | | | | | | | | | | | | | | | | | | | | | | | | | | | | | | | | | | | | | | | | | | | | | | | | | | | | | | | | | | | | | | | | | | | | | | | | | | | | | | | | | | | | | | | | | | | | | | | | | | | | | | |
| | 3" Caster & Frog Legs | <input type="checkbox"/> | <input type="checkbox"/> | <input type="checkbox"/> | <input type="checkbox"/> | <input type="checkbox"/> | <input type="checkbox"/> | <input type="checkbox"/> | | | | | | | | | | | | | | | | | | | | | | | | | | | | | | | | | | | | | | | | | | | | | | | | | | | | | | | | | | | | | | | | | | | | | | | | | | | | | | | | | | | | | | | | | | | | | | | | | | | | | | | | | |
| | 4" Caster & STD Forks | <input type="checkbox"/> | <input type="checkbox"/> | <input type="checkbox"/> | <input type="checkbox"/> | <input type="checkbox"/> | <input type="checkbox"/> | <input type="checkbox"/> | | | | | | | | | | | | | | | | | | | | | | | | | | | | | | | | | | | | | | | | | | | | | | | | | | | | | | | | | | | | | | | | | | | | | | | | | | | | | | | | | | | | | | | | | | | | | | | | | | | | | | | | | |
| | 4" Caster & Springs | <input type="checkbox"/> | <input type="checkbox"/> | <input type="checkbox"/> | <input type="checkbox"/> | <input type="checkbox"/> | <input type="checkbox"/> | <input type="checkbox"/> | | | | | | | | | | | | | | | | | | | | | | | | | | | | | | | | | | | | | | | | | | | | | | | | | | | | | | | | | | | | | | | | | | | | | | | | | | | | | | | | | | | | | | | | | | | | | | | | | | | | | | | | | |
| | 4" Caster & Frog Legs | <input type="checkbox"/> | <input type="checkbox"/> | <input type="checkbox"/> | <input type="checkbox"/> | <input type="checkbox"/> | <input type="checkbox"/> | <input type="checkbox"/> | | | | | | | | | | | | | | | | | | | | | | | | | | | | | | | | | | | | | | | | | | | | | | | | | | | | | | | | | | | | | | | | | | | | | | | | | | | | | | | | | | | | | | | | | | | | | | | | | | | | | | | | | |
| | 5" Caster & STD Forks | <input type="checkbox"/> | <input type="checkbox"/> | <input type="checkbox"/> | <input type="checkbox"/> | <input type="checkbox"/> | <input type="checkbox"/> | <input type="checkbox"/> | | | | | | | | | | | | | | | | | | | | | | | | | | | | | | | | | | | | | | | | | | | | | | | | | | | | | | | | | | | | | | | | | | | | | | | | | | | | | | | | | | | | | | | | | | | | | | | | | | | | | | | | | |
| | 5" Caster & Springs | <input type="checkbox"/> | <input type="checkbox"/> | <input type="checkbox"/> | <input type="checkbox"/> | <input type="checkbox"/> | <input type="checkbox"/> | <input type="checkbox"/> | | | | | | | | | | | | | | | | | | | | | | | | | | | | | | | | | | | | | | | | | | | | | | | | | | | | | | | | | | | | | | | | | | | | | | | | | | | | | | | | | | | | | | | | | | | | | | | | | | | | | | | | | |
| 5" Caster & Frog Legs | <input type="checkbox"/> | <input type="checkbox"/> | <input type="checkbox"/> | <input type="checkbox"/> | <input type="checkbox"/> | <input type="checkbox"/> | <input type="checkbox"/> | | | | | | | | | | | | | | | | | | | | | | | | | | | | | | | | | | | | | | | | | | | | | | | | | | | | | | | | | | | | | | | | | | | | | | | | | | | | | | | | | | | | | | | | | | | | | | | | | | | | | | | | | | |
| 8. REAR SEAT HEIGHT | <input type="checkbox"/> 14.5" <input type="checkbox"/> 15.0" <input type="checkbox"/> 15.5" <input type="checkbox"/> 16.0" <input type="checkbox"/> 16.5" <input type="checkbox"/> 17.0" <input type="checkbox"/> 17.5" <input type="checkbox"/> 18.0" <input type="checkbox"/> 18.5" <input type="checkbox"/> 19" | | \$ STD | | | | | | | | | | | | | | | | | | | | | | | | | | | | | | | | | | | | | | | | | | | | | | | | | | | | | | | | | | | | | | | | | | | | | | | | | | | | | | | | | | | | | | | | | | | | | | | | | | | | | | | | | | | | | | |
| <table border="1" style="width:100%; border-collapse: collapse;"> <tr> <td colspan="2" style="text-align:center;">Rear Seat Height Ranges</td> <td style="text-align:center;">Rear Tire Size</td> <td style="text-align:center;">Rear Seat Height</td> </tr> <tr> <td colspan="2"></td> <td>24"x1"(540)</td> <td>14.5"- 18.0"</td> </tr> <tr> <td colspan="2"></td> <td>24"x1 3/8"(540)</td> <td>15.0"- 18.0"</td> </tr> <tr> <td colspan="2"></td> <td>25"x1"(559)</td> <td>15.5"- 18.0"</td> </tr> <tr> <td colspan="2"></td> <td>24"x2"(540)</td> <td>15.5"- 18.5"</td> </tr> <tr> <td colspan="2"></td> <td>26"x1"(590)</td> <td>15.5"- 19.0"</td> </tr> <tr> <td colspan="2"></td> <td>25"x1.95"(559)</td> <td>16.0"- 19.0"</td> </tr> </table> | | | | Rear Seat Height Ranges | | Rear Tire Size | Rear Seat Height | | | 24"x1"(540) | 14.5"- 18.0" | | | 24"x1 3/8"(540) | 15.0"- 18.0" | | | 25"x1"(559) | 15.5"- 18.0" | | | 24"x2"(540) | 15.5"- 18.5" | | | 26"x1"(590) | 15.5"- 19.0" | | | 25"x1.95"(559) | 16.0"- 19.0" | | | | | | | | | | | | | | | | | | | | | | | | | | | | | | | | | | | | | | | | | | | | | | | | | | | | | | | | | | | | | | | | | | | | | | | | | | | | | | | | | | |
| Rear Seat Height Ranges | | Rear Tire Size | Rear Seat Height | | | | | | | | | | | | | | | | | | | | | | | | | | | | | | | | | | | | | | | | | | | | | | | | | | | | | | | | | | | | | | | | | | | | | | | | | | | | | | | | | | | | | | | | | | | | | | | | | | | | | | | | | | | | | | |
| | | 24"x1"(540) | 14.5"- 18.0" | | | | | | | | | | | | | | | | | | | | | | | | | | | | | | | | | | | | | | | | | | | | | | | | | | | | | | | | | | | | | | | | | | | | | | | | | | | | | | | | | | | | | | | | | | | | | | | | | | | | | | | | | | | | | | |
| | | 24"x1 3/8"(540) | 15.0"- 18.0" | | | | | | | | | | | | | | | | | | | | | | | | | | | | | | | | | | | | | | | | | | | | | | | | | | | | | | | | | | | | | | | | | | | | | | | | | | | | | | | | | | | | | | | | | | | | | | | | | | | | | | | | | | | | | | |
| | | 25"x1"(559) | 15.5"- 18.0" | | | | | | | | | | | | | | | | | | | | | | | | | | | | | | | | | | | | | | | | | | | | | | | | | | | | | | | | | | | | | | | | | | | | | | | | | | | | | | | | | | | | | | | | | | | | | | | | | | | | | | | | | | | | | | |
| | | 24"x2"(540) | 15.5"- 18.5" | | | | | | | | | | | | | | | | | | | | | | | | | | | | | | | | | | | | | | | | | | | | | | | | | | | | | | | | | | | | | | | | | | | | | | | | | | | | | | | | | | | | | | | | | | | | | | | | | | | | | | | | | | | | | | |
| | | 26"x1"(590) | 15.5"- 19.0" | | | | | | | | | | | | | | | | | | | | | | | | | | | | | | | | | | | | | | | | | | | | | | | | | | | | | | | | | | | | | | | | | | | | | | | | | | | | | | | | | | | | | | | | | | | | | | | | | | | | | | | | | | | | | | |
| | | 25"x1.95"(559) | 16.0"- 19.0" | | | | | | | | | | | | | | | | | | | | | | | | | | | | | | | | | | | | | | | | | | | | | | | | | | | | | | | | | | | | | | | | | | | | | | | | | | | | | | | | | | | | | | | | | | | | | | | | | | | | | | | | | | | | | | |
| 9. CENTER OF GRAVITY | <input type="checkbox"/> 1.0" <input type="checkbox"/> 1.5" <input type="checkbox"/> 2.0" <input type="checkbox"/> 2.5" <input type="checkbox"/> 3.0" <input type="checkbox"/> 3.5" <input type="checkbox"/> 4.0" <input type="checkbox"/> 4.5" <input type="checkbox"/> 5.0" <input type="checkbox"/> 5.5" | | \$ STD | | | | | | | | | | | | | | | | | | | | | | | | | | | | | | | | | | | | | | | | | | | | | | | | | | | | | | | | | | | | | | | | | | | | | | | | | | | | | | | | | | | | | | | | | | | | | | | | | | | | | | | | | | | | | | |
| <table border="1" style="width:100%; border-collapse: collapse;"> <tr> <td colspan="2" rowspan="2" style="text-align:center;"> Your Center of Gravity </td> <td colspan="9"></td> </tr> <tr> <td style="width:10%;">1.0"</td> <td style="width:10%;">1.5"</td> <td style="width:10%;">2.0"</td> <td style="width:10%;">2.5"</td> <td style="width:10%;">3.0"</td> <td style="width:10%;">3.5"</td> <td style="width:10%;">4.0"</td> <td style="width:10%;">4.5"</td> <td style="width:10%;">5.0"</td> <td style="width:10%;">5.5"</td> </tr> <tr> <td rowspan="8" style="writing-mode: vertical-rl; transform: rotate(180deg);">Your Seat Depth</td> <td>13"</td> <td><input type="checkbox"/></td> <td><input type="checkbox"/></td> <td><input type="checkbox"/></td> <td><input type="checkbox"/></td> <td><input type="checkbox"/></td> <td><input type="checkbox"/></td> <td><input type="checkbox"/></td> <td><input type="checkbox"/></td> <td><input type="checkbox"/></td> <td><input type="checkbox"/></td> </tr> <tr> <td>14"</td> <td><input type="checkbox"/></td> <td><input type="checkbox"/></td> <td><input type="checkbox"/></td> <td><input type="checkbox"/></td> <td><input type="checkbox"/></td> <td><input type="checkbox"/></td> <td><input type="checkbox"/></td> <td><input type="checkbox"/></td> <td><input type="checkbox"/></td> <td><input type="checkbox"/></td> </tr> <tr> <td>15"</td> <td><input type="checkbox"/></td> <td><input type="checkbox"/></td> <td><input type="checkbox"/></td> <td><input type="checkbox"/></td> <td><input type="checkbox"/></td> <td><input type="checkbox"/></td> <td><input type="checkbox"/></td> <td><input type="checkbox"/></td> <td><input type="checkbox"/></td> <td><input type="checkbox"/></td> </tr> <tr> <td>16"</td> <td><input type="checkbox"/></td> <td><input type="checkbox"/></td> <td><input type="checkbox"/></td> <td><input type="checkbox"/></td> <td><input type="checkbox"/></td> <td><input type="checkbox"/></td> <td><input type="checkbox"/></td> <td><input type="checkbox"/></td> <td><input type="checkbox"/></td> <td><input type="checkbox"/></td> </tr> <tr> <td>17"</td> <td><input type="checkbox"/></td> <td><input type="checkbox"/></td> <td><input type="checkbox"/></td> <td><input type="checkbox"/></td> <td><input type="checkbox"/></td> <td><input type="checkbox"/></td> <td><input type="checkbox"/></td> <td><input type="checkbox"/></td> <td><input type="checkbox"/></td> <td><input type="checkbox"/></td> </tr> <tr> <td>18"</td> <td><input type="checkbox"/></td> <td><input type="checkbox"/></td> <td><input type="checkbox"/></td> <td><input type="checkbox"/></td> <td><input type="checkbox"/></td> <td><input type="checkbox"/></td> <td><input type="checkbox"/></td> <td><input type="checkbox"/></td> <td><input type="checkbox"/></td> <td><input type="checkbox"/></td> </tr> <tr> <td>19"</td> <td><input type="checkbox"/></td> <td><input type="checkbox"/></td> <td><input type="checkbox"/></td> <td><input type="checkbox"/></td> <td><input type="checkbox"/></td> <td><input type="checkbox"/></td> <td><input type="checkbox"/></td> <td><input type="checkbox"/></td> <td><input type="checkbox"/></td> <td><input type="checkbox"/></td> </tr> <tr> <td>20"</td> <td><input type="checkbox"/></td> <td><input type="checkbox"/></td> <td><input type="checkbox"/></td> <td><input type="checkbox"/></td> <td><input type="checkbox"/></td> <td><input type="checkbox"/></td> <td><input type="checkbox"/></td> <td><input type="checkbox"/></td> <td><input type="checkbox"/></td> <td><input type="checkbox"/></td> </tr> </table> | | | | Your Center of Gravity | | | | | | | | | | | 1.0" | 1.5" | 2.0" | 2.5" | 3.0" | 3.5" | 4.0" | 4.5" | 5.0" | 5.5" | Your Seat Depth | 13" | <input type="checkbox"/> | <input type="checkbox"/> | <input type="checkbox"/> | <input type="checkbox"/> | <input type="checkbox"/> | <input type="checkbox"/> | <input type="checkbox"/> | <input type="checkbox"/> | <input type="checkbox"/> | <input type="checkbox"/> | 14" | <input type="checkbox"/> | <input type="checkbox"/> | <input type="checkbox"/> | <input type="checkbox"/> | <input type="checkbox"/> | <input type="checkbox"/> | <input type="checkbox"/> | <input type="checkbox"/> | <input type="checkbox"/> | <input type="checkbox"/> | 15" | <input type="checkbox"/> | <input type="checkbox"/> | <input type="checkbox"/> | <input type="checkbox"/> | <input type="checkbox"/> | <input type="checkbox"/> | <input type="checkbox"/> | <input type="checkbox"/> | <input type="checkbox"/> | <input type="checkbox"/> | 16" | <input type="checkbox"/> | <input type="checkbox"/> | <input type="checkbox"/> | <input type="checkbox"/> | <input type="checkbox"/> | <input type="checkbox"/> | <input type="checkbox"/> | <input type="checkbox"/> | <input type="checkbox"/> | <input type="checkbox"/> | 17" | <input type="checkbox"/> | <input type="checkbox"/> | <input type="checkbox"/> | <input type="checkbox"/> | <input type="checkbox"/> | <input type="checkbox"/> | <input type="checkbox"/> | <input type="checkbox"/> | <input type="checkbox"/> | <input type="checkbox"/> | 18" | <input type="checkbox"/> | <input type="checkbox"/> | <input type="checkbox"/> | <input type="checkbox"/> | <input type="checkbox"/> | <input type="checkbox"/> | <input type="checkbox"/> | <input type="checkbox"/> | <input type="checkbox"/> | <input type="checkbox"/> | 19" | <input type="checkbox"/> | <input type="checkbox"/> | <input type="checkbox"/> | <input type="checkbox"/> | <input type="checkbox"/> | <input type="checkbox"/> | <input type="checkbox"/> | <input type="checkbox"/> | <input type="checkbox"/> | <input type="checkbox"/> | 20" | <input type="checkbox"/> | <input type="checkbox"/> | <input type="checkbox"/> | <input type="checkbox"/> | <input type="checkbox"/> | <input type="checkbox"/> | <input type="checkbox"/> | <input type="checkbox"/> | <input type="checkbox"/> | <input type="checkbox"/> |
| Your Center of Gravity | | | | | | | | | | | | | | | | | | | | | | | | | | | | | | | | | | | | | | | | | | | | | | | | | | | | | | | | | | | | | | | | | | | | | | | | | | | | | | | | | | | | | | | | | | | | | | | | | | | | | | | | | | | | | | | | | |
| | | 1.0" | 1.5" | 2.0" | 2.5" | 3.0" | 3.5" | 4.0" | 4.5" | 5.0" | 5.5" | | | | | | | | | | | | | | | | | | | | | | | | | | | | | | | | | | | | | | | | | | | | | | | | | | | | | | | | | | | | | | | | | | | | | | | | | | | | | | | | | | | | | | | | | | | | | | | | | | | | | | |
| Your Seat Depth | 13" | <input type="checkbox"/> | <input type="checkbox"/> | <input type="checkbox"/> | <input type="checkbox"/> | <input type="checkbox"/> | <input type="checkbox"/> | <input type="checkbox"/> | <input type="checkbox"/> | <input type="checkbox"/> | <input type="checkbox"/> | | | | | | | | | | | | | | | | | | | | | | | | | | | | | | | | | | | | | | | | | | | | | | | | | | | | | | | | | | | | | | | | | | | | | | | | | | | | | | | | | | | | | | | | | | | | | | | | | | | | | | |
| | 14" | <input type="checkbox"/> | <input type="checkbox"/> | <input type="checkbox"/> | <input type="checkbox"/> | <input type="checkbox"/> | <input type="checkbox"/> | <input type="checkbox"/> | <input type="checkbox"/> | <input type="checkbox"/> | <input type="checkbox"/> | | | | | | | | | | | | | | | | | | | | | | | | | | | | | | | | | | | | | | | | | | | | | | | | | | | | | | | | | | | | | | | | | | | | | | | | | | | | | | | | | | | | | | | | | | | | | | | | | | | | | | |
| | 15" | <input type="checkbox"/> | <input type="checkbox"/> | <input type="checkbox"/> | <input type="checkbox"/> | <input type="checkbox"/> | <input type="checkbox"/> | <input type="checkbox"/> | <input type="checkbox"/> | <input type="checkbox"/> | <input type="checkbox"/> | | | | | | | | | | | | | | | | | | | | | | | | | | | | | | | | | | | | | | | | | | | | | | | | | | | | | | | | | | | | | | | | | | | | | | | | | | | | | | | | | | | | | | | | | | | | | | | | | | | | | | |
| | 16" | <input type="checkbox"/> | <input type="checkbox"/> | <input type="checkbox"/> | <input type="checkbox"/> | <input type="checkbox"/> | <input type="checkbox"/> | <input type="checkbox"/> | <input type="checkbox"/> | <input type="checkbox"/> | <input type="checkbox"/> | | | | | | | | | | | | | | | | | | | | | | | | | | | | | | | | | | | | | | | | | | | | | | | | | | | | | | | | | | | | | | | | | | | | | | | | | | | | | | | | | | | | | | | | | | | | | | | | | | | | | | |
| | 17" | <input type="checkbox"/> | <input type="checkbox"/> | <input type="checkbox"/> | <input type="checkbox"/> | <input type="checkbox"/> | <input type="checkbox"/> | <input type="checkbox"/> | <input type="checkbox"/> | <input type="checkbox"/> | <input type="checkbox"/> | | | | | | | | | | | | | | | | | | | | | | | | | | | | | | | | | | | | | | | | | | | | | | | | | | | | | | | | | | | | | | | | | | | | | | | | | | | | | | | | | | | | | | | | | | | | | | | | | | | | | | |
| | 18" | <input type="checkbox"/> | <input type="checkbox"/> | <input type="checkbox"/> | <input type="checkbox"/> | <input type="checkbox"/> | <input type="checkbox"/> | <input type="checkbox"/> | <input type="checkbox"/> | <input type="checkbox"/> | <input type="checkbox"/> | | | | | | | | | | | | | | | | | | | | | | | | | | | | | | | | | | | | | | | | | | | | | | | | | | | | | | | | | | | | | | | | | | | | | | | | | | | | | | | | | | | | | | | | | | | | | | | | | | | | | | |
| | 19" | <input type="checkbox"/> | <input type="checkbox"/> | <input type="checkbox"/> | <input type="checkbox"/> | <input type="checkbox"/> | <input type="checkbox"/> | <input type="checkbox"/> | <input type="checkbox"/> | <input type="checkbox"/> | <input type="checkbox"/> | | | | | | | | | | | | | | | | | | | | | | | | | | | | | | | | | | | | | | | | | | | | | | | | | | | | | | | | | | | | | | | | | | | | | | | | | | | | | | | | | | | | | | | | | | | | | | | | | | | | | | |
| | 20" | <input type="checkbox"/> | <input type="checkbox"/> | <input type="checkbox"/> | <input type="checkbox"/> | <input type="checkbox"/> | <input type="checkbox"/> | <input type="checkbox"/> | <input type="checkbox"/> | <input type="checkbox"/> | <input type="checkbox"/> | | | | | | | | | | | | | | | | | | | | | | | | | | | | | | | | | | | | | | | | | | | | | | | | | | | | | | | | | | | | | | | | | | | | | | | | | | | | | | | | | | | | | | | | | | | | | | | | | | | | | | |
| 10. CAMBER ANGLE | <input type="checkbox"/> 2° <input type="checkbox"/> 4° <input type="checkbox"/> 6° | | \$ STD | | | | | | | | | | | | | | | | | | | | | | | | | | | | | | | | | | | | | | | | | | | | | | | | | | | | | | | | | | | | | | | | | | | | | | | | | | | | | | | | | | | | | | | | | | | | | | | | | | | | | | | | | | | | | | |
| 11. SEAT TO FRONT OF FOOTREST | <input type="checkbox"/> 15.0" <input type="checkbox"/> 15.5" <input type="checkbox"/> 16.0" <input type="checkbox"/> 16.5" <input type="checkbox"/> 17.0" <input type="checkbox"/> 17.5" <input type="checkbox"/> 18.0" <input type="checkbox"/> 18.5" <input type="checkbox"/> 19.0" <input type="checkbox"/> 19.5" | | \$ STD | | | | | | | | | | | | | | | | | | | | | | | | | | | | | | | | | | | | | | | | | | | | | | | | | | | | | | | | | | | | | | | | | | | | | | | | | | | | | | | | | | | | | | | | | | | | | | | | | | | | | | | | | | | | | | |
| *Measurement must be 1.5" shorter than your Front Seat Height | | | | | | | | | | | | | | | | | | | | | | | | | | | | | | | | | | | | | | | | | | | | | | | | | | | | | | | | | | | | | | | | | | | | | | | | | | | | | | | | | | | | | | | | | | | | | | | | | | | | | | | | | | | | | | | | | |
| HIGH MOUNT <small>With Risers or Clamps</small> | <input type="checkbox"/> 10.0" <input type="checkbox"/> 10.5" <input type="checkbox"/> 11.0" <input type="checkbox"/> 11.5" <input type="checkbox"/> 12.0" <input type="checkbox"/> 12.5" <input type="checkbox"/> 13.0" <input type="checkbox"/> 13.5" <input type="checkbox"/> 14.0" <input type="checkbox"/> 14.5" | | \$ 65 | | | | | | | | | | | | | | | | | | | | | | | | | | | | | | | | | | | | | | | | | | | | | | | | | | | | | | | | | | | | | | | | | | | | | | | | | | | | | | | | | | | | | | | | | | | | | | | | | | | | | | | | | | | | | | |
| *Not Available with Single Flip-Back Foot Plate | | | | | | | | | | | | | | | | | | | | | | | | | | | | | | | | | | | | | | | | | | | | | | | | | | | | | | | | | | | | | | | | | | | | | | | | | | | | | | | | | | | | | | | | | | | | | | | | | | | | | | | | | | | | | | | | | |
| 12. INSIDE WHEEL CLEARANCE | <input type="checkbox"/> 3/4" * <input type="checkbox"/> 1" <input type="checkbox"/> 1 1/4" <input type="checkbox"/> 1 1/2" <input type="checkbox"/> 1 3/4" <input type="checkbox"/> 2" | | \$ STD | | | | | | | | | | | | | | | | | | | | | | | | | | | | | | | | | | | | | | | | | | | | | | | | | | | | | | | | | | | | | | | | | | | | | | | | | | | | | | | | | | | | | | | | | | | | | | | | | | | | | | | | | | | | | | |
| *3/4" Inside wheel clearance not available with 2 degree camber. (with the exception of Y-360 wheels) | | | | | | | | | | | | | | | | | | | | | | | | | | | | | | | | | | | | | | | | | | | | | | | | | | | | | | | | | | | | | | | | | | | | | | | | | | | | | | | | | | | | | | | | | | | | | | | | | | | | | | | | | | | | | | | | | |
| *3/4" Inside wheel clearance not available with Armrest *3/4" Inside wheel clearance not available with Bite Hub Locked | | | | | | | | | | | | | | | | | | | | | | | | | | | | | | | | | | | | | | | | | | | | | | | | | | | | | | | | | | | | | | | | | | | | | | | | | | | | | | | | | | | | | | | | | | | | | | | | | | | | | | | | | | | | | | | | | |
| *3/4" Inside wheel clearance not available with D's Locks | | | | | | | | | | | | | | | | | | | | | | | | | | | | | | | | | | | | | | | | | | | | | | | | | | | | | | | | | | | | | | | | | | | | | | | | | | | | | | | | | | | | | | | | | | | | | | | | | | | | | | | | | | | | | | | | | |
| NOTE | Spazz is a custom-made wheelchair. If you would like to customize your Spazz beyond what is available on this order form please submit your request here. Colours will determine as to whether this request can be accomplished while maintaining the safety and integrity of the wheelchair. If it can be accomplished the quote will reflect any and all custom charges, thank you. | | | | | | | | | | | | | | | | | | | | | | | | | | | | | | | | | | | | | | | | | | | | | | | | | | | | | | | | | | | | | | | | | | | | | | | | | | | | | | | | | | | | | | | | | | | | | | | | | | | | | | | | | | | | | | | | |
| Sub Total Section B 1/2 | | | \$ | | | | | | | | | | | | | | | | | | | | | | | | | | | | | | | | | | | | | | | | | | | | | | | | | | | | | | | | | | | | | | | | | | | | | | | | | | | | | | | | | | | | | | | | | | | | | | | | | | | | | | | | | | | | | | |
| Sub Total Section B 2/2 | | | \$ | | | | | | | | | | | | | | | | | | | | | | | | | | | | | | | | | | | | | | | | | | | | | | | | | | | | | | | | | | | | | | | | | | | | | | | | | | | | | | | | | | | | | | | | | | | | | | | | | | | | | | | | | | | | | | |
| Total Section B | | | \$ | | | | | | | | | | | | | | | | | | | | | | | | | | | | | | | | | | | | | | | | | | | | | | | | | | | | | | | | | | | | | | | | | | | | | | | | | | | | | | | | | | | | | | | | | | | | | | | | | | | | | | | | | | | | | | |

C WHEELS, TIRES & CASTERS, FORKS 1/2

| WHEELS | | | | | | | | | | | | | | | |
|--|--|---|-------------|------------|-------------|--------|--------|--|-------|---------|--|-----------|---|---|--------|
| Standard Radial Spoke Wheel <input type="checkbox"/> 24" (540) Only | | | \$ STD | | | | | | | | | | | | |
| Heat-Treated Wheel <input type="checkbox"/> 24" (540) <input type="checkbox"/> 25" (559) <input type="checkbox"/> 26" (590) | | | \$ 252 | | | | | | | | | | | | |
| Cross Knot Laced Spokes <input type="checkbox"/> 24" (540) <input type="checkbox"/> 25" (559) <input type="checkbox"/> 26" (590) <small>*Not available with D's Lock</small> | | | \$ 211 | | | | | | | | | | | | |
| Twister Super Strength wheel <input type="checkbox"/> 24" (540) <input type="checkbox"/> 25" (559) <input type="checkbox"/> 26" (590) <small>*Not available with D's Lock</small> | | | \$ 310 | | | | | | | | | | | | |
| Bite Hub Locked Wheels <input type="checkbox"/> 24" (540) <input type="checkbox"/> 25" (559) | | | \$ 799 | | | | | | | | | | | | |
| Y-360 Billet Wheels <input type="checkbox"/> 24" (540) <input type="checkbox"/> 25" (559) <small>(*Camber 0- 2° max)</small> Style <input type="checkbox"/> Saw Blade <input type="checkbox"/> Hearts(25"only) <input type="checkbox"/> T-Style(25"only) | | | \$ 999 | | | | | | | | | | | | |
| Y-360 Billet Wheels MOD Style <input type="checkbox"/> 25" (559) Only <small>(*Camber 0- 2° max)</small> Style <input type="checkbox"/> Tribal Sun <input type="checkbox"/> Girls <input type="checkbox"/> Eagle <input type="checkbox"/> Holy Cross <input type="checkbox"/> Hono Specify Powder Coat Color for Insert Only () *Choose from Frame Colors | | | \$ 1,499 | | | | | | | | | | | | |
| Extra Options for Y-360 <input type="checkbox"/> Bite Hub Locked (\$600 up charge) <input type="checkbox"/> Spinners Clover (\$650 up charge) <input type="checkbox"/> Powder-Coated Spokes Only () (\$150 up charge) <small>*Choose from Frame Colors</small> | | | | | | | | | | | | | | | |
| X-Core (3 Spokes comp) <input type="checkbox"/> 25" (559) Only <small>(*Camber 0- 2° max)</small> Wheel Color <input type="checkbox"/> Black <input type="checkbox"/> Yellow <input type="checkbox"/> Blue <input type="checkbox"/> Red <input type="checkbox"/> White | | | \$ 743 | | | | | | | | | | | | |
| | | | \$ 943 | | | | | | | | | | | | |
| Spinergy Spox 18 Spokes | <input type="checkbox"/> 24" (540) <input type="checkbox"/> 25" (559) <input type="checkbox"/> 26" (590) Spoke Color <input type="checkbox"/> Black <input type="checkbox"/> Red <input type="checkbox"/> Yellow <input type="checkbox"/> Blue <input type="checkbox"/> White <small>With Silver Hub With Black Hub With Black Hub With Black Hub With Black Hub</small> | | \$ 695 | | | | | | | | | | | | |
| | <input type="checkbox"/> Custom Color Spoke Pattern | <table border="1"> <thead> <tr> <th></th> <th>Left Wheel</th> <th>Right Wheel</th> </tr> </thead> <tbody> <tr> <td>Spokes</td> <td>Inside</td> <td></td> </tr> <tr> <td>Color</td> <td>Outside</td> <td></td> </tr> <tr> <td>Hub Color</td> <td><input type="checkbox"/> Black/<input type="checkbox"/> Silver</td> <td><input type="checkbox"/> Black/<input type="checkbox"/> Silver</td> </tr> </tbody> </table> | | Left Wheel | Right Wheel | Spokes | Inside | | Color | Outside | | Hub Color | <input type="checkbox"/> Black/ <input type="checkbox"/> Silver | <input type="checkbox"/> Black/ <input type="checkbox"/> Silver | \$ 795 |
| | | Left Wheel | Right Wheel | | | | | | | | | | | | |
| Spokes | Inside | | | | | | | | | | | | | | |
| Color | Outside | | | | | | | | | | | | | | |
| Hub Color | <input type="checkbox"/> Black/ <input type="checkbox"/> Silver | <input type="checkbox"/> Black/ <input type="checkbox"/> Silver | | | | | | | | | | | | | |
| | | | | | | | | | | | | | | | |
| Spinergy LX 12 Spokes | <input type="checkbox"/> 24" (540) <input type="checkbox"/> 25" (559) <input type="checkbox"/> 26" (590) Spoke Color <input type="checkbox"/> Black <input type="checkbox"/> Red <input type="checkbox"/> Yellow <input type="checkbox"/> Blue <small>With Silver Hub With Black Hub With Black Hub With Black Hub</small> <input type="checkbox"/> White <input type="checkbox"/> Neon Green <input type="checkbox"/> Pink <input type="checkbox"/> Orange <small>With Black Hub With Black Hub With Black Hub With Black Hub</small> | | \$ 895 | | | | | | | | | | | | |
| | <input type="checkbox"/> Custom Color Spoke Pattern | <table border="1"> <thead> <tr> <th></th> <th>Left Wheel</th> <th>Right Wheel</th> </tr> </thead> <tbody> <tr> <td>Spokes</td> <td>Inside</td> <td></td> </tr> <tr> <td>Color</td> <td>Outside</td> <td></td> </tr> <tr> <td>Hub Color</td> <td><input type="checkbox"/> Black/<input type="checkbox"/> Silver</td> <td><input type="checkbox"/> Black/<input type="checkbox"/> Silver</td> </tr> </tbody> </table> | | Left Wheel | Right Wheel | Spokes | Inside | | Color | Outside | | Hub Color | <input type="checkbox"/> Black/ <input type="checkbox"/> Silver | <input type="checkbox"/> Black/ <input type="checkbox"/> Silver | \$ 995 |
| | | Left Wheel | Right Wheel | | | | | | | | | | | | |
| Spokes | Inside | | | | | | | | | | | | | | |
| Color | Outside | | | | | | | | | | | | | | |
| Hub Color | <input type="checkbox"/> Black/ <input type="checkbox"/> Silver | <input type="checkbox"/> Black/ <input type="checkbox"/> Silver | | | | | | | | | | | | | |
| | | | | | | | | | | | | | | | |
| Topolino Cabon Core WX2.5 Wheels Black Spokes Only <input type="checkbox"/> 24" (540) <input type="checkbox"/> 25" (559) <small>w/ Aluminum Gray Anodized Handrim</small> <small>*Not available with D's Lock</small> Nipples Color <input type="checkbox"/> Red <input type="checkbox"/> Yellow | | | \$ 1,095 | | | | | | | | | | | | |
| Pro Wheels <input type="checkbox"/> 24" (540) <input type="checkbox"/> 25" (559) <small>w/ Aluminum Color Anodized Handrim</small> <small>*Not available with D's Lock</small> Spoke & Handrim Color <input type="checkbox"/> Anodized Black <input type="checkbox"/> Anodized Red <input type="checkbox"/> Anodized Blue | | | \$ 825 | | | | | | | | | | | | |
| MAGIC WHEELS → See Magic Wheels Order Form For Wheel, Handrim, Tire, Option \$4,995 Size: <input type="checkbox"/> 24" (540) <input type="checkbox"/> 25" (559) Handrims (\$) Tires (\$) | | | \$ — | | | | | | | | | | | | |
| HANDRIMS | | | | | | | | | | | | | | | |
| Type | <input type="checkbox"/> Standard For 24", 25" or 26" Wheel Anodized Black *Not available with Topolino Wheels, Pro Wheels | | \$ STD | | | | | | | | | | | | |
| | <input type="checkbox"/> Vinyl Coated For 24", 25", 26" Wheel *Not available with Topolino Wheels, Pro Wheels | | \$ 142 | | | | | | | | | | | | |
| | <input type="checkbox"/> Ultra Grip For 24", 25", 26" Wheel *Not available with Topolino Wheels, Pro Wheels | | \$ 395 | | | | | | | | | | | | |
| | <input type="checkbox"/> Grip-It For 24", 25", 26" Wheel *Not available with Topolino Wheels, Pro Wheels | | \$ 295 | | | | | | | | | | | | |
| | <input type="checkbox"/> Spinergy Flex Rim Available only on 24" and 25" Spinergy LX. | | \$ 495 | | | | | | | | | | | | |
| | <input type="checkbox"/> Projections Handrims *Not available with Y-360 Billet Wheels, X-Core, Topolino Wheels, Pro Wheels Wheel Size: <input type="checkbox"/> 24" <input type="checkbox"/> 25" / Projections Angle: <input type="checkbox"/> Vertical <input type="checkbox"/> Oblique / Number of Projections: <input type="checkbox"/> 8 <input type="checkbox"/> 12 | E0967 | \$ 240 | | | | | | | | | | | | |
| TAB LENGTH <input type="checkbox"/> Long Tabs (STD inside clearance 3/4") | | \$ STD | | | | | | | | | | | | | |
| <input type="checkbox"/> Short Tabs (Inside clearance 1/2") *Not available with Ultra Grip | | \$ STD | | | | | | | | | | | | | |
| <input type="checkbox"/> Short Tab (Set closest to wheel cut off excess) *Not available with Ultra Grip, Y-360 wheel, X-Core, Topolino Wheels, Pro Wheels | | \$ 15 | | | | | | | | | | | | | |

C WHEELS, TIRES & CASTERS, FORKS 2/2

| TIRES | | | | | |
|-----------------------------|--|---|--|------------------------|-----------|
| <input type="checkbox"/> | High Pressure Tire | <input type="checkbox"/> 24"x1", <input type="checkbox"/> 25"x1" or <input type="checkbox"/> 26"x1" | Gray Tire with black wall Only | E2211/E2212 | \$ STD |
| <input type="checkbox"/> | High Pressure Tire | <input type="checkbox"/> 24"x1", <input type="checkbox"/> 25"x1" or <input type="checkbox"/> 26"x1" | <input type="checkbox"/> Blue <input type="checkbox"/> Red | E2211/E2212 | \$ 65 |
| <input type="checkbox"/> | Low Pressure Tire | <input type="checkbox"/> 24"x1-3/8" or <input type="checkbox"/> 26"x1-3/8" | Gray Only | E2211/E2212 | \$ STD |
| <input type="checkbox"/> | E2211Schwalbe Marathon Plus High Pressure Tire | <input type="checkbox"/> 24"x1", <input type="checkbox"/> 25"x1" or <input type="checkbox"/> 26"x1" | Black Only | E2211/E2212 | \$ 99 |
| <input type="checkbox"/> | Solid Tire | <input type="checkbox"/> 24"x1", <input type="checkbox"/> 25"x1" or <input type="checkbox"/> 26"x1" | Dark Gray Only | E2218 | \$ 135 |
| <input type="checkbox"/> | E2211 Moderate V-Track Knobby Tire | 24"x1-3/8" (37-540) | Gray Only | E2211/E2212 | \$ 117 |
| <input type="checkbox"/> | E2211 Aggressive Knobby Tire | 24"x 2" (50-540) | Gray with Blue Wall Only | E2211/E2212 | \$ 117 |
| <input type="checkbox"/> | E2211 Aggressive Knobby Tire | 25"x 1.95" (50-559) | Black Only | E2211/E2212 | \$ 117 |
| <input type="checkbox"/> | E2213 Flat-Free Inserts For 24"x1-3/8" Tires Only | | | E2211/E2213 | \$ 117 |
| CASTERS | | | | | |
| SIZE | TIRE WIDTH | HUB COLOR | TIRE COLOR | DESCRIPTION | |
| <input type="checkbox"/> 3" | 1" | Black Hub | Black Tire Only | Polyeurathane | \$ STD |
| <input type="checkbox"/> 3" | 1" | Plastic Black Hub | Clear Tire Only | Lighted, Polyeurathane | \$ 65 |
| <input type="checkbox"/> 3" | 1" | Red Hub | Red Tire Only | Polyeurathane | \$ STD |
| <input type="checkbox"/> 3" | 1" | Black Hub | Clear Tire Only | Polyeurathane | \$ STD |
| <input type="checkbox"/> 3" | 1" | Aluminum Silver Hub | Black Tire Only | | \$ 160 |
| <input type="checkbox"/> 3" | 1" | Aluminum Black Hub | Black Tire Only | | \$ 160 |
| <input type="checkbox"/> 4" | 1" | Plastic Black Hub | Black Tire Only | | \$ STD |
| <input type="checkbox"/> 4" | 1" | Plastic Black Hub | Clear Only | Lighted, Polyeurathane | \$ 65 |
| <input type="checkbox"/> 4" | 1" | Aluminum Silver Hub | Black Tire Only | | \$ 160 |
| <input type="checkbox"/> 4" | 1" | Aluminum Black Hub | Black Tire Only | | \$ 160 |
| <input type="checkbox"/> 4" | 1.5" | Composite Black Hub | Tire <input type="checkbox"/> Black <input type="checkbox"/> Blue <input type="checkbox"/> Red | Soft Roll | \$ 120 |
| <input type="checkbox"/> 4" | 1.5" | Aluminum Silver Hub | Tire <input type="checkbox"/> Black <input type="checkbox"/> Blue <input type="checkbox"/> Red | Soft Roll | \$ 160 |
| <input type="checkbox"/> 4" | 1.5" | Aluminum Black Hub | Black Tire Only | Soft Roll | \$ 160 |
| <input type="checkbox"/> 5" | 1" | Composite Black Hub | Black Tire Only | | \$ STD |
| <input type="checkbox"/> 5" | 1" | Plastic Black Hub | Clear Tire Only | Lighted, Polyeurathane | \$ 65 |
| <input type="checkbox"/> 5" | 1" | Aluminum Black Hub | Black Tire Only | | \$ 160 |
| <input type="checkbox"/> 5" | 1.5" | Composite Black Hub | Tire <input type="checkbox"/> Black <input type="checkbox"/> Blue <input type="checkbox"/> Red | Soft Roll | \$ 120 |
| <input type="checkbox"/> 5" | 1.5" | Aluminum Silver Hub | Tire <input type="checkbox"/> Black <input type="checkbox"/> Blue <input type="checkbox"/> Red | Soft Roll | \$ 160 |
| <input type="checkbox"/> 5" | 1.5" | Aluminum Black Hub | Black Tire Only | Soft Roll | \$ 160 |
| FORKS | | | | | |
| <input type="checkbox"/> | STD Aluminum Forks | Black Only | | | \$ STD |
| | Extra Options for Aluminum Forks | <input type="checkbox"/> With Suspension Springs | | E1015 | \$ 55 |
| | | <input type="checkbox"/> With Quick Release Axles | | K0073 | \$ 107 |
| <input type="checkbox"/> | Frog Leg Suspension Forks Std 1" Wide (For 3", 4" x 1" width Caster and 5" lighted Caster) | (Not available with Quick Release Axles) | Color <input type="checkbox"/> Anodized Black <input type="checkbox"/> Anodized Silver | E1015 | \$ 535 |
| <input type="checkbox"/> | Frog Leg Suspension Forks 1.5" Wide (For 3", 4" x 1.5" width Caster and 5" Caster) | (Not available with Quick Release Axles) | Color <input type="checkbox"/> Anodized Black <input type="checkbox"/> Anodized Silver | E1015 | \$ 535 |
| Sub Total Section C 1/2 | | | | | \$ |
| Sub Total Section C 2/2 | | | | | \$ |
| Total Section C | | | | | \$ |

D COMPONENTS

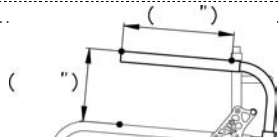
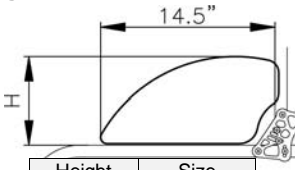
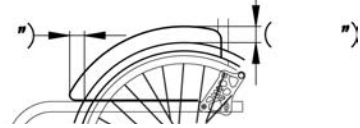
| WHEEL LOCKS | | | | | | | | |
|---|--------|------------------|------|------|-----|-------|--------|--|
| <input type="checkbox"/> Push to Lock / Anodized Black Only | | \$ STD | | | | | | |
| <input type="checkbox"/> NEW Compact Push to Lock / Anodized Black Only <input type="checkbox"/> w/ 2" Extension Handle (\$65 up charge) | | \$ 110 | | | | | | |
| <input type="checkbox"/> NEW Compact Scissor Lock / Anodized Black Only | | \$ 110 | | | | | | |
| <input type="checkbox"/> D's Locks (*Not available with Twister, Y-360, Topolino WX2.5, Pro Wheels, Magic wheels) (*Does not include installation fee) | | \$ 624 | | | | | | |
| * <input type="checkbox"/> Installation fee for D's Locks (\$250) * Installation of OEM parts subject to flat fee labor charge | | | | | | | | |
| PUSH HANDLES | | | | | | | | |
| <input type="checkbox"/> Integrated w/Fixed Backrest Height / Anodized Black Only | | \$ STD | | | | | | |
| <input type="checkbox"/> Bolt-on / Anodized Black Only Specify Height from floor (") | | \$ 142 | | | | | | |
| <input type="checkbox"/> Bolt-on Height Adj. & Quick Release / Anodized Black Only Overall Length <input type="checkbox"/> 12" <input type="checkbox"/> 16" <input type="checkbox"/> 20" <input type="checkbox"/> Custom(") | | \$ 295 | | | | | | |
| ARM RESTS | | | | | | | | |
| <input type="checkbox"/> Aluminum, Padded – Swing Away (Adj. Height Range 6" - 12.5") Set at _____ " from Seat / Anodized Black Only | E0973 | \$ 225 | | | | | | |
| <input type="checkbox"/> Custom Length & Height Aluminum, Padded – Swing Away Armrests Anodized Black Only | E0973 | \$ 375 | | | | | | |
|  | | | | | | | | |
| ANTI-TIPPERS | | | | | | | | |
| <input type="checkbox"/> Anti-Tippers (pair) w/ Quick Release / Anodized Black Only | E0971 | \$ 112 | | | | | | |
| SIDE GUARDS | | | | | | | | |
| <input type="checkbox"/> Rigid Side Guards - Black ABS <input type="checkbox"/> Non-Removable <input type="checkbox"/> Removable <input type="checkbox"/> Removable w/Hole (\$10 up charge) | | \$ 142 | | | | | | |
| Size: <input type="checkbox"/> STD <input type="checkbox"/> Medium <input type="checkbox"/> Cut to Wheel (\$98 up charge) Color: Black Only | | | | | | | | |
| <input type="checkbox"/> Rigid Side Guards - Aluminum <input type="checkbox"/> Non-Removable <input type="checkbox"/> Removable | | \$ 197 | | | | | | |
| Size: <input type="checkbox"/> Medium Only <input type="checkbox"/> Cut to Wheel (\$98 up charge) Color <input type="checkbox"/> Black (STD) <input type="checkbox"/> Pol. Aluminum (STD) <input type="checkbox"/> Powder Coated () (\$50 up charge) <input type="checkbox"/> Gold Plate (+CFP) | | | | | | | | |
|  | | | | | | | | |
| <table border="1" style="display: inline-table; margin-right: 20px;"> <tr> <th>Height</th> <th>Size</th> </tr> <tr> <td>7.5"</td> <td>STD</td> </tr> <tr> <td>8.25"</td> <td>Medium</td> </tr> </table> | | Height | Size | 7.5" | STD | 8.25" | Medium | |
| Height | Size | | | | | | | |
| 7.5" | STD | | | | | | | |
| 8.25" | Medium | | | | | | | |
|  | | | | | | | | |
| <input type="checkbox"/> PRO-TEX Fender Guards / (Black ABS -Only) <input type="checkbox"/> Cut to Fit Specs <input type="checkbox"/> Do Not Install | | \$ 175 | | | | | | |
| <input type="checkbox"/> Fabric Clothing Guards Black Nylon w/Velcro | | \$ 78 | | | | | | |
| SEAT CUSHION | | | | | | | | |
| <input type="checkbox"/> Foam Cushion w/Nylon Cover Thickness <input type="checkbox"/> 1" <input type="checkbox"/> 2" <input type="checkbox"/> 3" <input type="checkbox"/> 4" | | \$ 78 | | | | | | |
| *Please see section E for other cushion choices. | | | | | | | | |
| MISCELLANEOUS | | | | | | | | |
| <input type="checkbox"/> Frame Protectors / Black Leather/Zipper Type | | \$ 78 | | | | | | |
| <input type="checkbox"/> K0065 Spoke Protectors / Black Only <input type="checkbox"/> 24" <input type="checkbox"/> 25" <input type="checkbox"/> 26" | K0065 | \$ 107 | | | | | | |
| <input type="checkbox"/> E0978 Seat Belt w/Auto Buckle (BP) 1.5" Black Belt Only | E0978 | \$ 69 | | | | | | |
| <input type="checkbox"/> Tie Down Brackets 4pcs. | | \$ 210 | | | | | | |
| SPECIALTY PARTS | | | | | | | | |
| <input type="checkbox"/> Wheelchair Tray (Alum.) Size: <input type="checkbox"/> 11" x 13" <input type="checkbox"/> 13" x 15" <input type="checkbox"/> 13" x 17" | | \$ 250 | | | | | | |
| Color: <input type="checkbox"/> Raw Alum. <input type="checkbox"/> Black Alum. <input type="checkbox"/> Polish Alum.(\$250 up charge) | | | | | | | | |
| <input type="checkbox"/> Ski Tips on Caster Forks | | \$ 275 | | | | | | |
| UPHOLSTERY CHOICE & COLOR *Positioning Back Available. Please see Section E | | | | | | | | |
| <input type="checkbox"/> Standard Adjustable Ht Backrest Black Only | | \$ STD | | | | | | |
| <input type="checkbox"/> Adjustable Tension Backrest Black Only (*Not available with 8" Backrest Height) | | \$ 135 | | | | | | |
| Custom Options <input type="checkbox"/> Custom Colored For Std. or Adj. Style <input type="checkbox"/> Black <input type="checkbox"/> Red | | (\$60 up charge) | | | | | | |
| <input type="checkbox"/> Fabrics for Fun For Std. or Adj. Style <input type="checkbox"/> 001 <input type="checkbox"/> 002 <input type="checkbox"/> 003 <input type="checkbox"/> 004 <input type="checkbox"/> 006 <input type="checkbox"/> 010 <input type="checkbox"/> 011 | | (\$95 up charge) | | | | | | |
| <input type="checkbox"/> 014 <input type="checkbox"/> 015 <input type="checkbox"/> 016 <input type="checkbox"/> 017 <input type="checkbox"/> 018 <input type="checkbox"/> 020 <input type="checkbox"/> 021 | | | | | | | | |
| <input type="checkbox"/> 022 <input type="checkbox"/> 023 <input type="checkbox"/> 024 <input type="checkbox"/> 025 <input type="checkbox"/> 026 <input type="checkbox"/> 027 <input type="checkbox"/> 028 | | | | | | | | |
| <input type="checkbox"/> Backrest Leather Trim (outside panels) | | (\$77 up charge) | | | | | | |
| <input type="checkbox"/> Calf Strap <input type="checkbox"/> Black <input type="checkbox"/> Matching Fabric (\$55 up charge) -Select Fabric () | K0038 | \$ 24 | | | | | | |
| <input type="checkbox"/> Matching Fabric on Padded Side Guards –Select Fabric () | | \$ 210 | | | | | | |
| <input type="checkbox"/> Cushion Cover (Std. Foam Cushion Only)–Select Fabric () Width _____ " Depth _____ " Thickness _____ " | | \$ 90 | | | | | | |
| Total Section D \$ | | | | | | | | |

E CHAIR OPTIONS 1/2

| SEAT CUSHION | | | |
|--|--|---|--------|
| SUPRACOR® WHEELCHAIR CUSHIONS | | | |
| Stimulite® Contoured Cushion *Black Upholstery only | <input type="checkbox"/> W14"xD16" (CD1416) | E2603 | \$ 525 |
| | <input type="checkbox"/> W16"xD16" (CD1616) | E2603 | \$ 525 |
| | <input type="checkbox"/> W16"xD18" (CD1618) | E2603 | \$ 525 |
| | <input type="checkbox"/> W18"xD16" (CD1816) | E2603 | \$ 525 |
| | <input type="checkbox"/> W18"xD18" (CD1818) | E2603 | \$ 525 |
| | <input type="checkbox"/> W18"xD20" (CD1820) | E2603 | \$ 540 |
| | <input type="checkbox"/> W20"xD16" (CD2016) | E2603 | \$ 540 |
| | <input type="checkbox"/> W20"xD18" (CD2018) | E2603 | \$ 540 |
| | <input type="checkbox"/> W20"xD20" (CD2020) | E2603 | \$ 555 |
| | | <input type="checkbox"/> Extra Sensitive (\$30 up charge) <input type="checkbox"/> Sling Style Bottom (\$45 up charge) <input type="checkbox"/> Custom Size W(") x D(") (\$45 up charge) | |
| Stimulite® Slimline Cushion *Black Upholstery only | <input type="checkbox"/> W14"xD16" (SM1416) | E2603 | \$ 495 |
| | <input type="checkbox"/> W16"xD16" (SM1616) | E2603 | \$ 495 |
| | <input type="checkbox"/> W16"xD18" (SM1618) | E2603 | \$ 495 |
| | <input type="checkbox"/> W18"xD18" (SM1818) | E2603 | \$ 495 |
| | <input type="checkbox"/> W18"xD20" (SM1820) | E2603 | \$ 495 |
| | <input type="checkbox"/> W20"xD16" (SM2016) | E2603 | \$ 510 |
| | <input type="checkbox"/> W20"xD18" (SM2018) | E2603 | \$ 510 |
| | <input type="checkbox"/> W20"xD20" (SM2020) | E2603 | \$ 510 |
| | <input type="checkbox"/> Extra Sensitive (\$30 up charge) <input type="checkbox"/> Sling Style Bottom (\$45 up charge) <input type="checkbox"/> Custom Size W(") x D(") (\$45 up charge) | | |
| Stimulite® Corbee Pediatric *Black Upholstery only | <input type="checkbox"/> W10"xD10" (PD1010) | E2603 | \$ 450 |
| | <input type="checkbox"/> W12"xD12" (PD1212) | E2603 | \$ 450 |
| | <input type="checkbox"/> W14"xD14" (PD1414) | E2603 | \$ 450 |
| | <input type="checkbox"/> Extra Sensitive (\$30 up charge) <input type="checkbox"/> Sling Style Bottom (\$45 up charge) <input type="checkbox"/> Custom Size W(") x D(") (\$45 up charge) | | |
| ROHO WHEELCHAIR CUSHIONS | | | |
| <input type="checkbox"/> 4" HIGH PROFILE® QUADTRO SELECT® CUSHION | Width (") x Depth (") | E2622-2623 | \$ 525 |
| *Available 12"-24" width *Black Upholstery only | | | |
| <input type="checkbox"/> 3" MID PROFILE® QUADTRO SELECT® CUSHION | *Black Upholstery only -Choose Size | E2622-2623 | \$ 525 |
| <input type="checkbox"/> W15"xD15 <input type="checkbox"/> W15"xD16 <input type="checkbox"/> W16"xD16 <input type="checkbox"/> W16"xD18 <input type="checkbox"/> W18"xD16" <input type="checkbox"/> W18"xD18" | | | |
| <input type="checkbox"/> 2" LOW PROFILE® QUADTRO SELECT® CUSHION | *Black Upholstery only Width (") x Depth (") | E2622-2623 | \$ 525 |
| *Available 12"-20" width | | | |
| <input type="checkbox"/> 2" NEXUS SPIRIT® CUSHION | *Black Upholstery only -Choose Size | E2622 | \$ 525 |
| <input type="checkbox"/> W15"xD15 <input type="checkbox"/> W16"xD16 <input type="checkbox"/> W16"xD18 <input type="checkbox"/> W17"xD17 <input type="checkbox"/> W18"xD16" <input type="checkbox"/> W18"xD18" <input type="checkbox"/> W20"xD18" | | | |
| STAR CUSHIONS | | | |
| Galaxy Cushion *Black Upholstery only | <input type="checkbox"/> W14"xD14" (GXY 1414-2) | E2624 | \$ 405 |
| | <input type="checkbox"/> W14"xD16" (GXY 1416-2) | | |
| | <input type="checkbox"/> W16"xD14" (GXY 1614-2) | | |
| | <input type="checkbox"/> W16"xD16" (GXY 1616-2) | | |
| | <input type="checkbox"/> W16"xD18" (GXY 1618-2) | | |
| | <input type="checkbox"/> W18"xD16" (GXY 1816-2) | | |
| | <input type="checkbox"/> W18"xD18" (GXY 1818-2) | | |
| | <input type="checkbox"/> W18"xD20" (GXY 1820-2) | | |
| | <input type="checkbox"/> W20"xD16" (GXY 2016-2) | | |
| | <input type="checkbox"/> W20"xD20" (GXY 2020-2) | | |
| | Choose Zoning Options <input type="checkbox"/> Standard - Dual Valve <input type="checkbox"/> Dual Valve - Front to Back <input type="checkbox"/> Four Valve <input type="checkbox"/> Simple - Single Valve <input type="checkbox"/> Four Valve - Enhanced <input type="checkbox"/> Four Valve - Front to Back | | |
| NOTE | | | |

E CHAIR OPTIONS 2/2

POSITIONING BACK

ADI CARBON BACKREST (Support Contour-ACTIVE 2.5") *Not Available with Welded Side Guards

Mounting Hardware: **2 Point Pro** **Quick Release**

| | | | | |
|--------|--|----------------------------|--------------|--------|
| Height | <input type="checkbox"/> LOW (10" Height) *Available 13"-19" width | Width (")..... | E2613 | \$ 745 |
| | <input type="checkbox"/> Medium (13" Height) *Available 13"-19" width | Width (")..... | E2613 | \$ 815 |
| | <input type="checkbox"/> Standard (16" Height) *Available 13"-19" width | Width (")..... | E2613 | \$ 880 |

ADI ALUMINUM BACKREST (Support Contour-ACTIVE 2.5") *Not Available with Welded Side Guards

Mounting Hardware: **2 Point Pro** **Quick Release**

| | | | | |
|--------|--|----------------------------|--------------|--------|
| Height | <input type="checkbox"/> LOW (10" Height) *Available 10"-20" width | Width (")..... | E2613 | \$ 610 |
| | <input type="checkbox"/> Medium (13" Height) *Available 12"-20" width | Width (")..... | E2613 | \$ 625 |
| | <input type="checkbox"/> Standard (16" Height) *Available 14"-20" width | Width (")..... | E2613 | \$ 640 |
| | <input type="checkbox"/> Tall (18" Height) *Available 16"-20" width | Width (")..... | E2613 | \$ 655 |
| | <input type="checkbox"/> X-Tall (20" Height) *Available 16"-20" width | Width (")..... | E2613 | \$ 670 |

ADI ALUMINUM BACKREST (Support Contour-DEEP 4") *Not Available with Welded Side Guards

Mounting Hardware: **2 Point Pro** **Quick Release**

| | | | | |
|--------|--|----------------------------|--------------|--------|
| Height | <input type="checkbox"/> LOW (10" Height) *Available 10"-20" width | Width (")..... | E2615 | \$ 710 |
| | <input type="checkbox"/> Medium (13" Height) *Available 12"-20" width | Width (")..... | E2615 | \$ 725 |
| | <input type="checkbox"/> Standard (16" Height) *Available 14"-20" width | Width (")..... | E2615 | \$ 740 |
| | <input type="checkbox"/> Tall (18" Height) *Available 16"-20" width | Width (")..... | E2615 | \$ 755 |
| | <input type="checkbox"/> X-Tall (20" Height) *Available 16"-20" width | Width (")..... | E2615 | \$ 770 |

OTHER

| | |
|--|--------|
| <input type="checkbox"/> ADI Transfer Board <input type="checkbox"/> 21" (ADV21) <input type="checkbox"/> 24" (ADV24) <input type="checkbox"/> 29" (ADV29)..... | \$ 62 |
| <input type="checkbox"/> ADI Push and Transfer Gloves Leather (one size fits)..... | \$ 60 |
| <input type="checkbox"/> ADI Carbon Solid Seat (Wide: 18" Max, Depth: 20" Max)..... | \$ 625 |
| <input type="checkbox"/> ADI Folding Carbon Side Guard | \$ 400 |
| <input type="checkbox"/> ADI Fixed Carbon Side | \$ 375 |

NOTE

Sub Total Section E 1/2 \$

Sub Total Section E 2/2 \$

Total Section E \$

F SPECIAL PARTS COLORS (Please allow an additional 1-2 weeks delivery)

| PARTS COLORS | | | | | | |
|-----------------------|----------------------|----------------------|------------------|---------------|------------------|-------------|
| Powder-Coated | Gloss Black | Twilight Flake | Yellow | Magenta | Fire Engine Red | White |
| | Candy Blue | Candy Purple | Candy Green | Candy Red | Candy Raspberry | Cobalt Blue |
| | Matte Gray | Matte Purple | Matte Blue | Matte Green | Matte Black | Matte Red |
| | Neon Red | Neon Green | Orange Sparkle | Mellon Yellow | Gun Smoke Silver | Pigeon Blue |
| | Copper | Granny Sparkle Green | Sparkle Sky Blue | Vermilion | Reed Green | Blue Lilac |
| Special Colors | Polished Aluminum | | | | | |
| | 24 karat Gold Plated | | | | | |

Please Choose the Color for each Part

*Parts not selected will be black color. (Suspension Spring: Silver Color)

*Minimum 3 parts selected per order.

*PC=Powder-Coated

Saddle Stops

| | |
|---|-------|
| <input type="checkbox"/> PC () | \$40 |
| <input type="checkbox"/> Polished..... | \$115 |
| <input type="checkbox"/> Gold Plated..... | \$CFP |

Backrest

| | |
|---|-------|
| <input type="checkbox"/> PC () | \$185 |
| <input type="checkbox"/> Polished..... | \$225 |
| <input type="checkbox"/> Gold Plated..... | \$CFP |

Backrest Brackets

| | |
|---|-------|
| <input type="checkbox"/> PC () | \$90 |
| <input type="checkbox"/> Polished..... | \$115 |
| <input type="checkbox"/> Gold Plated..... | \$CFP |

Foot Plate

| | |
|---|-------|
| <input type="checkbox"/> PC () | \$45 |
| <input type="checkbox"/> Polished..... | \$90 |
| <input type="checkbox"/> Gold Plated..... | \$CFP |

Footrest Rings

| | |
|---|-------|
| <input type="checkbox"/> PC () | \$20 |
| <input type="checkbox"/> Polished..... | \$40 |
| <input type="checkbox"/> Gold Plated..... | \$CFP |

Footrest Tubes

| | |
|---|-------|
| <input type="checkbox"/> PC () | \$65 |
| <input type="checkbox"/> Polished..... | \$85 |
| <input type="checkbox"/> Gold Plated..... | \$CFP |

Foot Plate Clamps

| | |
|---|-------|
| <input type="checkbox"/> PC () | \$50 |
| <input type="checkbox"/> Polished..... | \$75 |
| <input type="checkbox"/> Gold Plated..... | \$CFP |

Caps

| | |
|---|------|
| <input type="checkbox"/> PC () | \$20 |
| <input type="checkbox"/> Polished..... | N/A |
| <input type="checkbox"/> Gold Plated..... | N/A |

Caster Housing

| | |
|---|-------|
| <input type="checkbox"/> PC () | \$150 |
| <input type="checkbox"/> Polished..... | \$280 |
| <input type="checkbox"/> Gold Plated..... | N/A |

Front Springs

| | |
|---|------|
| <input type="checkbox"/> PC () | \$20 |
| <input type="checkbox"/> Polished..... | N/A |
| <input type="checkbox"/> Gold Plated..... | N/A |

Forks & Knurl Nuts

| | |
|---|-------|
| <input type="checkbox"/> PC () | \$65 |
| <input type="checkbox"/> Polished..... | \$90 |
| <input type="checkbox"/> Gold Plated..... | \$CFP |

Axle Bases

| | |
|---|-------|
| <input type="checkbox"/> PC () | \$50 |
| <input type="checkbox"/> Polished..... | \$75 |
| <input type="checkbox"/> Gold Plated..... | \$CFP |

Axle Tube

| | |
|---|-------|
| <input type="checkbox"/> PC () | \$50 |
| <input type="checkbox"/> Polished..... | \$75 |
| <input type="checkbox"/> Gold Plated..... | \$CFP |

Axle Plates

| | |
|---|-------|
| <input type="checkbox"/> PC () | \$65 |
| <input type="checkbox"/> Polished..... | \$85 |
| <input type="checkbox"/> Gold Plated..... | \$CFP |

Camber Plates

| | |
|---|-------|
| <input type="checkbox"/> PC () | \$50 |
| <input type="checkbox"/> Polished..... | \$75 |
| <input type="checkbox"/> Gold Plated..... | \$CFP |

Total Section F \$